

MultiMix12 FireWire 

MultiMix16 FireWire 

Reference Manual

ALESIS

This page intentionally left blank



Table Of Contents

Introduction.....	5
Welcome!.....	5
About the MultiMix FireWire.....	6
All-In-One Mixer and Multichannel Computer Audio Interface	6
MultiMix FireWire Key Features	6
Additional Features of the MultiMix 12 FireWire and MultiMix 16 FireWire.....	7
How to Use This Manual	8
A Few Words for Beginners.....	9
Hooking up the MultiMix FireWire	11
Using Proper Cables	12
Setting Levels	12
Chapter Two: A Tour of the MultiMix.....	13
Patchbay	13
Mic Inputs (Channels 1 – 4).....	13
Line Inputs (Channels 1 – 4).....	13
Line Inputs (Channels 5 – 12)	14
S/PDIF Digital Output Jack.....	14
PHONE Jack.....	14
AUX RETURNS	14
AUX SENDS.....	14
ALT 3/4 OUT	14
2-TRACK.....	14
MAIN MIX OUT.....	15
CTRL RM OUT	15
Channel Strips	15
Fader	15
MUTE / Alt 3/4.....	15
PFL / SOLO.....	15
PAN or BAL.....	16
Aux.....	16
EQ.....	16
Master Section.....	17
Main Mix Fader.....	17
Alt 3/4 Fader.....	17
2TK To Mix.....	17
Alt 3/4 To Mix.....	17
Solo Mode.....	17
HDPH / CTRL RM.....	18
MIX Switch.....	18
ALT 3/4 Switch	18
2TK Switch.....	18
Aux Ret A Level.....	18
Effects / Aux Ret B level	18
LED Meters.....	19
POWER Indicator	19

Table Of Contents

+48V Indicator	19
Rear of the Mixer	20
Power Input	20
Power Supply Unit	20
Power On	20
Phantom On	20
Firewire ports	20

Chapter Three: Digital Effects

Processor	21
Effects Section Components	21
Program Selection Knob	21
LED Display	21
CLIP Indicator	21
SIG Indicator	21
Effect Descriptions.....	21
HALL	21
ROOM	21
PLATE	21
CHAMBER	21
CHORUS	22
FLANGE	22
DELAY	22
PITCH	22
MULTI & MULTI II	22

Chapter Four: Traditional Mixing.....23

Simple Live Setup.....	23
Using Additional External Audio Sources	23
S/PDIF digital output to a digital recorder	23

Chapter Five: Firewire Recording25

First-time connection instructions.....	25
and driver installation	25
Installing the optional applications.....	26
Power-on/Power off order	26
Power-on sequence.....	26
Power-off sequence.....	26
Firewire inputs and outputs	27
Channels sent from the MultiMix to the computer.....	27
Channels returned from the computer to the MultiMix	27
Sound setup under Windows	28
Disabling Windows System Sounds.....	30
Connections and settings for Firewire	
recording and monitoring	31
Using the MultiMix FireWire with Cubase	
and other ASIO applications.....	31
Choosing the MultiMix as your audio device	32

Creating a new audio file	36
Working with the ASIO control panel.....	40
Accessing the ASIO control panel.....	40
Setting the mixer nickname	40
Setting the master device	40
Adjusting latency by changing the buffer size	41
Adjusting the sample rate	41
Using the MultiMix FireWire with Sonar and other WDM applications	42
Choosing the MultiMix as your audio device	42
Assigning inputs to audio tracks.....	45
Using the MultiMix FireWire with CoreAudio on the Macintosh	46
 Chapter Six: Troubleshooting: non- Firewire	 47
 Chapter Seven: Troubleshooting: Firewire	 51
Computer or audio application does not see the MultiMix FireWire.....	51
Basic troubleshooting.....	51
Advanced troubleshooting under Windows	51
Audio playback or recording is at the wrong speed.....	53
Audio playback or recording stutters or drops out.....	53
Audio echoes during recording.....	53
 Chapter Eight: Specifications.....	 55
 Chapter Nine: Block Diagram.....	 57
 Glossary	 59
 Contact	 62
Alesis Contact Information.....	62
Trademarks	62

Table Of Contents

This page intentionally left blank

Introduction

Welcome!

Thank you for making the Alesis MultiMix FireWire a part of your studio. Since 1984, we've been designing and building creative tools for the audio community. We believe in our products, because we've heard the results that creative people like you have achieved with them. One of Alesis' goals is to make high-quality studio equipment available to everyone, and this Reference Manual is an important part of that. After all, there's no point in making equipment with all kinds of capabilities if no one explains how to use them. So, we try to write our manuals as carefully as we build our products.

The goal of this manual is to get you the information you need as quickly as possible, with a minimum of hassle. We hope we've achieved that. If not, please drop us an email and give us your suggestions on how we could improve future editions of this manual.

We hope your investment will bring you many years of creative enjoyment and help you achieve your musical goals.

Sincerely,
The people of Alesis

For more effective service and product update notices, please register your MultiMix FireWire mixer online at:

<http://www.alesis.com/index.php?registration>

About the MultiMix FireWire

The MultiMix FireWire mixers are the latest in the large family of Alesis audio mixers and the second series that includes computer interfacing (following on the launch of the MultiMix USB mixers in 2004).

We've come a long way since introducing our first mixing console in 1989. Since that time audio technology has grown in leaps and bounds, pushing up quality and driving down prices. Only a few years ago, you wouldn't have been able to buy a mixer with analog performance this powerful for such an affordable price, and the addition of multichannel computer audio interfacing would have been a pipe dream. Just take a look at the key features listed below, and you'll see that you have just made an incredible addition to your home studio or live setup.

All-In-One Mixer and Multichannel Computer Audio Interface

The MultiMix FireWire consoles give you just about everything you need to create polished, professional-sounding mixes both live and within a computer-based recording studio. When designing this unit, our goal was to give you as much control over your mixes as possible without requiring a wealth of extra equipment. That's why we added tools like the digital effects processor, the mic preamps, and the S/PDIF digital output (12- and 16-channel models only).

The MultiMix FireWire is also a full-duplex, multichannel computer recording interface device. Not only can you record every channel independently, but you can also record the MAIN mix channels. To get you started with computer-based recording, we even include a well-specified Digital Audio Workstation (DAW) software program. With a multitude of ways in which to connect other equipment and instruments, the MultiMix FireWire offers endless possibilities.

*Important: download the drivers from <http://www.alesis.com> onto a folder on your desktop or insert the software CD into your computer's CD drive **BEFORE** you plug your MultiMix into your computer for the first time.*

See page 25 for details.

MultiMix FireWire Key Features

- **Three Models:**
 - MultiMix 8 FireWire** (4 mic/line preamps, 2 stereo inputs)
 - MultiMix 12 FireWire** (4 mic/line preamps, 4 stereo inputs)
 - MultiMix 16 FireWire** (8 mic/line preamps, 4 stereo inputs)

- **Multichannel Firewire (IEEE 1394a) input and output** – routes each individual channel's output, plus the MAIN outputs, through the FIREWIRE port, and receives two channels back from the computer, all in 24-bit, 44.1/48 kHz digital audio.
- **ASIO and WDM computer drivers** – lets you use the MultiMix FireWire with the vast majority of digital audio workstation programs.
- **Clean and powerful preamps** – up to 50dB of preamp gain for capturing quiet sources. Globally switched phantom power.
- **Stereo inputs** – Two stereo pairs for the MultiMix 8 FireWire. Four stereo pairs for the 12- and 16-channel versions. Great for line-level instruments.
- **Internal digital effects processor with 100 preset effects and an easy-to-read display** – includes a variety of reverbs, delays, choruses, flanges, a pitch transposer and multiple combinations of these.
- **3-band EQ per channel** – a potent tool for sonically shaping each channel to get that perfect mix.
- **2 aux sends per channel** – one can be used to access an external effects device; the other can be used either to access the MultiMix's internal effects or to access a second external device. On the 12-channel and 16-channel MultiMix FireWires, the first aux send can be switched between either pre- or post-fader operation.
- **Control room output level** – provides control over the separate control room output.
- **2-track send and return** – lets you mix your audio to tape or other media and to add a tape deck or CD player to the mix.

Additional Features of the MultiMix 12 FireWire and MultiMix 16 FireWire

- **PFL/Solo in place functionality per channel** – isolates a channel with a single push of a button.
- **Mute/Alt 3/4 assign per channel** – lets you mute a channel and, at the same time, route its signal to the mixer's ALT 3/4 output—a separate stereo bus.
- **Independent Main Mix and Alt 3/4 levels** – permits you to separately command the levels of the MultiMix's two stereo buses
- **S/PDIF digital out** – sends the 24-bit, digital stereo signal directly to a DAT, DVD or other recording device that can accept a S/PDIF signal.

Introduction

How to Use This Manual

This manual is divided into the following sections describing the various functions and applications of the MultiMix consoles. While it's a good idea to read through the entire manual once carefully, those having general knowledge about mixing should use the table of contents to look up specific functions.

Chapter 1: Getting Started shows you how to include the MultiMix in your audio setup for recording, computer interfacing, and live applications. We've included a hookup diagram, guidelines for which cables to use and the vital steps you must take to set levels properly.

Chapter 2: A Tour of the MultiMix describes the MultiMix piece by piece. This chapter also features diagrams of the mixer to help you find each component as you read about it.

Chapter 3: Digital Effects Processor explains the effects provided by the on-board digital effects processor. If you want to know what a certain effect will do to your sound before you select it, this is where you should look.

Chapter 4: Traditional Mixing outlines a number of scenarios in which you can use the MultiMix for live mixing and simple, non-Firewire based recording.

Chapter 5: Firewire Recording orients you to the MultiMix's powerful Firewire recording features, including software installation and setup with common DAW programs.

Chapter 6: Troubleshooting can give you a hand if you're experiencing problems with your mixer. You'll find that most issues can be resolved simply and quickly with the push of a button.

Chapter 7: Specifications and Chapter 8: Block Diagrams are full of technical information for the more techie users.

And at the end of this manual you'll see a glossary of common mixing-related terms.

Helpful tips and advice are highlighted in a shaded box like this.



When something important appears in the manual, an exclamation mark (like the one shown at left) will appear with some explanatory text. This symbol indicates that this information is vital when operating the MultiMix consoles.

A Few Words for Beginners

We realize that some of you who have purchased the MultiMix FireWire are fairly new to the art of mixing and computer recording. We've written this manual with that in mind. We designed the MultiMix to be both powerful and easy enough to use that even a beginner can quickly pick up the basics.

Many mixer manuals—and manuals for just about any electronic instrument for that matter—are full of complicated terminology and incomplete instructions that presume a lot of experience on the part of the reader. We try to avoid that with this manual. True enough, you will find all the technical lingo and specifications you can handle in here, but we do our best to make this accessible to you.

Beginners will find several elements of this manual especially useful. Keep your eye out for the tips found in the gray boxes on the right side of the page. Be sure to check out the hookup diagrams on page 11, which will give you some ideas on how to fit the mixer into your audio setup after you've taken a tour of the mixer in Chapter 2. And if you come across any terms that you haven't seen before, the glossary probably can help you out.

One of the most important things you'll do before you begin a mixing session is to set the levels. Be sure to refer to the instructions on page 20.

Introduction

This page intentionally left blank.

1 Getting Started

*Important: download the drivers from <http://www.alesis.com> onto a folder on your desktop or insert the software CD into your computer's CD drive **BEFORE** you plug your MultiMix into your computer for the first time.*

See page 25 for details.

Hooking up the MultiMix FireWire

This diagram will help you get the MultiMix FireWire hooked up and ready to go. The equipment you use depends on personal preference and on whether you're performing live or recording. For example, you'll see below that the MAIN MIX OUT can be routed to a recording device for recording, or to a PA system for live performance.

Be sure to follow the guidelines for which cables to use (further down this page) and the procedure for setting levels (on the next page) before you begin mixing.

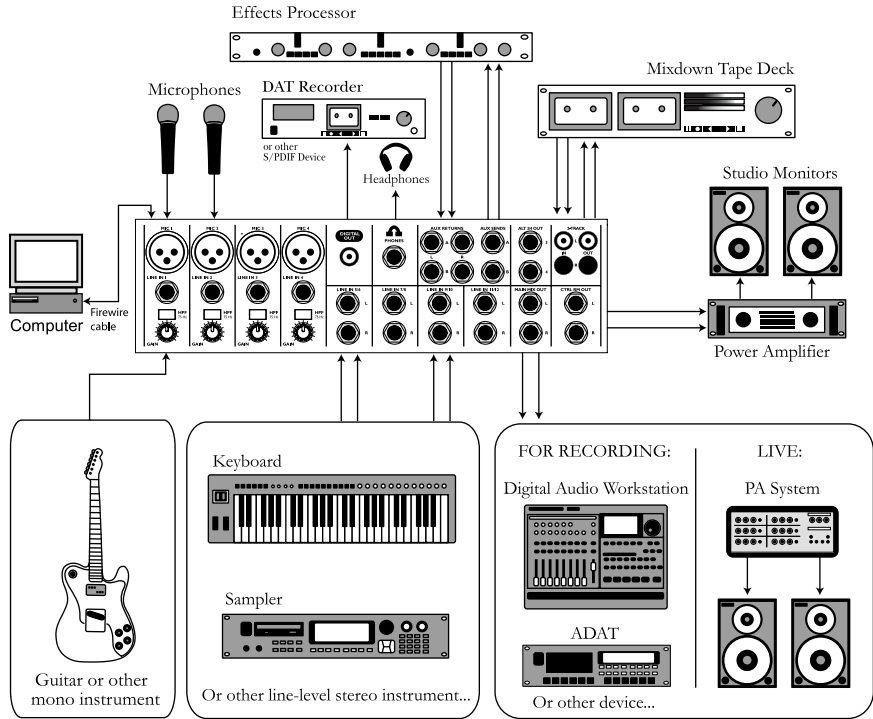

Using Proper Cables

When connecting instruments and other equipment to the MultiMix, it's important that you use the appropriate types of cables. Here are some simple but important guidelines:

- For the mic inputs, use XLR cables.
- For the line inputs and all other 1/4" connections, use 1/4" mono TRS cables.
- Use stereo RCA cables for the 2-track in and out.
- Use a Firewire (IEEE 1394a) cable to connect one of the Firewire ports to a computer.
- For the S/PDIF Digital out, we suggest that you use a coaxial cable that is specifically designed for S/PDIF applications. These cables are better suited for high frequency (digital) signals and are unbalanced, shielded coaxial cables with shielded RCA connectors on each end. Better to get the high quality S/PDIF cables and save yourself some unnecessary grief.

Setting Levels

Before you can begin mixing and recording different audio sources with your MultiMix, you must set the level for each channel you're using. This helps to prevent distortion and clipping. Here's how:

1. Slide the channel fader to unity gain (0).
2. Turn the AUX SEND and GAIN controls all the way down, and turn the EQ knobs to the center detent (you'll feel a click).
3. Connect the source of the signal to the channel's input.
4. Press the PFL / SOLO switch on the channel.
5. Make sure the SOLO MODE switch in the master section is set to SOLO.
6. Play the instrument at a normal level and watch the LED meters in the master section.
7. Adjust the channel's GAIN knob until the LED meters remain at or very close to 0.
8. If you need to apply EQ, do so and check the meters again.

2 A Tour of the MultiMix FireWire

In this chapter, you'll learn all about the MultiMix's components (except for the digital effects processor, which is explained in the next chapter). Please refer to the diagrams as you read each section to see which components we're talking about.

Patchbay

At the rear portion of the top of the MultiMix, you'll find the patchbay. This is where you plug in instruments, signal processors, multitrack recorders and other devices. Whatever you need to connect to the mixer, this is where it's done. In the following paragraphs, we tell you all about the inputs, outputs, switches and knobs you see in this section of the mixer.

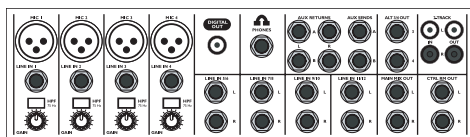

Patchbay

Mic Inputs (Channels 1 – 4)

The MultiMix uses standard XLR-type mic inputs. These provide +48V phantom power that you can turn on and off with the Phantom On switch located on the rear of the mixer. You probably will have to turn on the phantom power when you're using most condenser mics, as these usually require the extra voltage (unless the mic has its own power source, such as a battery). Dynamic and ribbon mics don't require phantom power and are unaffected when the power is on.

These high-quality mic inputs also feature up to 50dB of preamp gain that you can adjust with the Gain knob.

Another useful feature of these mic inputs is a high-pass filter (HPF) that can be turned on and off with the HPF switch. When you activate this switch, all frequencies below 75Hz are cut from the signal. This is useful for mic or line signals that don't have much bottom end, such as vocals, snares, cymbals and electric guitar. You'll want to leave this inactivated for instruments like basses and kick drums.

Line Inputs (Channels 1 – 4)

The line inputs, marked LINE IN, are balanced 1/4" jacks that offer the same 50dB of preamp gain and the high-pass filter provided by the mic inputs (however, phantom power does not apply to line inputs). These inputs accept line-level instruments such as keyboards and drum machines. If you find that your instrument has a weak line signal, just plug it into channels 1 – 4 and crank it up with the Gain knob.

Although chances are your microphones will work fine with these mic inputs, we recommend that you do some checking up on the type of microphone you're using, especially if it's one of the older vintage models. Verify that your microphone requires phantom power and make sure its output is low impedance, balanced and floating.

*Always connect your microphones **before** activating phantom power. Microphones tend to be very sensitive, and the sudden power surge can do permanent damage to the mic's circuitry. It's also a good idea to lower mixer levels before you activate phantom power.*

Line Inputs (Channels 5 – 12)

Unlike channels 1 – 4, the line inputs on channels 5 – 12 are stereo inputs that have left and right inputs. If you're using one of these channels as a mono input, plug your instrument into the left input. Channels 5 – 12 don't have the extra gain found on channels 1 – 4 because most line-level instruments don't require the extra boost. Synthesizers and other electronic instruments will work especially well on these channels. These inputs are also good for connecting CD players or tape decks, as these audio sources don't require extra gain.

S/PDIF Digital Output Jack

The digital output jack is used to send the stereo audio signal to an Alesis Masterlink or any other recording device such as a DAT recorder or a PC with an S/PDIF enabled sound card installed.

Always use a high quality cable when connecting the DIGITAL OUTPUT JACK to your recording device. We recommend that you use a cable that is specifically designed to carry a digital signal and does not exceed 5 meters (16.4 ft) in length.

PHONE Jack

The headphone jack accepts 1/4" jacks. If your headphones are 1/8", you can find a 1/8" to 1/4" adapter in most electronics stores.

AUX RETURNS

These are the 1/4" jacks where you connect the outputs of an external effects processor or other audio source. Each aux return gives you 15dB of gain that can be controlled by the AUX RET A and EFFECTS / AUX RET B LEVEL knobs in the mixer's output section.

AUX SENDS

And this is the 1/4" jack where you connect the cable that's going into the input of an external effects processor. The aux sends give you 10dB of gain that can be controlled in the AUX section of each channel input.

ALT 3/4 OUT

These jacks are the outputs for the MultiMix's extra stereo bus. This signal includes channels whose MUTE / ALT 3/4 switch is activated.

2-TRACK

The 2-TRACK IN and OUT jacks are standard RCA jacks. You'll use the OUTs for mixing to a tape deck or other recorder. With the INs you can bring in a signal, which can be monitored and

Any audio signal that is routed to the MAIN OUTPUTS will also be sent out of the DIGITAL OUTPUT jack. The level is controlled by the MAIN FADERS. The DIGITAL OUTPUT mirrors the output from the MAIN OUTPUTS.

The S/PDIF output operates by default at 44.1kHz. However, if the mixer is being used with a computer and the sample rate on the computer is set to 48kHz, the S/PDIF digital output will operate at 48kHz as well.

If you are using an effects device with only a mono output, plug it into the left return of STEREO AUX RETURN. It will appear in the center of the stereo spectrum, and not to the left.

even added to the main mix via the 2TK TO MIX switch in the master section of the mixer.

The 2-TRACK INPUT is blended with any signal coming back from a computer over the Firewire connection.

MAIN MIX OUT

These 1/4" jacks are where the signal on the main mix bus leaves the mixer. From there you can send it to a recorder or a PA system. The level of this signal is controlled by the MAIN MIX fader.

CTRL RM OUT

You can use these 1/4" jacks to send the control room signal to the input of the amplifier driving your monitors or headphones. This output can carry several different signals, depending on which source you have selected in the master section of the mixer.

Channel Strips

The eight channel strips are virtually identical to each other, with the only difference being that channels 1 – 4 are mono and channels 5 – 12 are stereo. Each channel strip contains the following components.

Fader

The fader controls how much of the signal from the mic or line inputs is sent to the channel. To adjust the level, simply slide the fader up and down to the desired level. In the lowest position, levels are cut completely, and in the uppermost position you get an additional 10dB of gain. When the fader is at 0, it is at unity gain, where the level of the output equals the level of the input.

MUTE / Alt 3/4

This switch has two purposes. The mute function is pretty self-explanatory: when you press the switch, the channel's output is no longer routed to the main mix output. The second purpose of this switch is that in addition to muting a channel, it also routes it to the ALT 3/4 OUT found in the patchbay. This is where you get the MultiMix's extra stereo bus. If you don't have anything connected to the ALT 3/4 OUT, the switch acts only as a mute button. If you do have something connected—say, a multitrack recorder—this button acts as a signal router.

PFL / SOLO

The PFL / SOLO switch allows you to single out a channel so you can make adjustments to it before you run it into the main mix. This is useful for setting an instrument's gain or EQ and for troubleshooting. PFL stands for "pre-fade listen." In other words

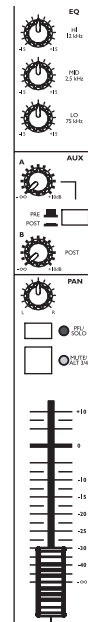

Channel Strip

this switch lets you hear the signal before it is affected by the fader. This switch is post-EQ.

PAN or BAL

This control—labeled PAN on the mono channels and BAL on the stereo channels—lets you assign the channel to a particular spot within the stereo spectrum. If you turn this knob to the left, you can hear the signal move to the left, and if you turn it to the right...you get the picture. The pan controls do this by adjusting the amount of the signal being sent to the left main mix bus versus the right main mix bus. The balance controls do it by controlling the relative balance of the left and right channel signals being sent to the left and right main mix buses.

Aux

Here you'll find knobs that control the levels of aux sends A and B. AUX A is either pre-fader or post-fader, depending on the position of the PRE / POST switch. When the switch is in the raised position, the aux send is pre-fader. When the switch is depressed, the aux send is post-fader.

What does all this mean? In POST mode the aux send is affected by the fader, EQ and HPF settings. In PRE mode the aux send is affected only by the EQ and HPF settings. POST mode is generally used for sending the signal to an external effects device (so that the fader controls the signal level), and PRE mode is usually used for cue sends (for example, sending a signal to headphones while recording, for which you may not want the fader to alter the channel's level).

AUX B is always post-fader, as indicated by the word "POST" to the right of this knob. Like AUX A, AUX B can be used for routing signals to external devices. And when you are using the onboard effects processor, AUX B is used to control the level of the channel's signal being routed to the processor.

EQ

The MultiMix gives you three bands of EQ per channel. Using these knobs, you can tailor the channel's signal by boosting some frequencies and cutting others. The LO and HI controls are shelving controls with fixed frequencies of 80 Hz and 12 kHz respectively. The MID control has a peaking response fixed at 2.5 kHz.

"Shelving" means that the mixer boosts or cuts all frequencies past the specified frequency. "Peaking" means that frequencies above and below the specified frequency fall off, forming a peak in a graphical representation.

Master Section

The Master Section is the heart of the mixer, where the channel inputs and aux returns all are mixed together and routed in various ways.

Main Mix Fader

The signals from all channels and aux sends—excluding those that are muted—are sent to the main mix. The MAIN MIX fader is the one you'll use to control the overall level of those combined signals. This fader affects the levels of the signals sent to the MAIN MIX OUT, the DIGITAL OUT (12FXD and 16FXD models only) and the 2-TRACK OUT. In its lowest position the signal is cut off completely, and in the uppermost position you get an additional 10dB of gain. In the 0 position the fader is at unity gain.

Alt 3/4 Fader

This fader controls the output of the Alt 3/4 bus.

2TK To Mix

When you press this switch, the signal coming in through the 2-TRACK IN gets routed to the MAIN MIX, joining whichever other signals are already part of the main mix. Used this way, the 2-TRACK IN effectively becomes another stereo channel (but without all the extras like pan, EQ, etc.).

The 2-TRACK IN signal combines both whatever is plugged into the 2-TRACK RCA jacks and also any audio coming back to the computer over Firewire.

Alt 3/4 To Mix

This switch adds the signal from the Alt 3/4 bus to the main mix bus.

Solo Mode

The SOLO MODE switch affects the signals of channels whose PFL / SOLO switches are engaged. When the SOLO MODE switch is in the up position, you're in PFL, or pre-fader listen mode. This means that you'll hear the signals of all soloed channels as they sound before they pass through their respective faders. You'll need to be in PFL mode when you're setting levels (see "Setting Channel Levels," page 12. This mode is post-EQ.

When the SOLO MODE switch is engaged (in the down position), you are in SOLO mode. This means that you will hear the output of every soloed channel (after it passes through its fader, pan and EQ).

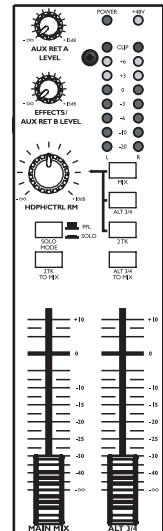

Master Section

The purpose of seeing a soloed channel's level on the LED meters is so that you can see the true level of that channel's signal. For that reason, the HDPH / CTRL RM knob does not change the LED meters' reading—it changes only the level at which you're listening to the soloed channel.

HDPH / CTRL RM

The HDPH / CTRL RM knob controls the level of the signal being sent to the CTRL RM OUT and the PHONES output. The level of this signal is represented by the LED meters. The switches to the right of the HDPH / CTRL RM knob determine the source of the control room mix as explained below. You can use these switches in any combination. If no switches are selected, you'll hear silence in the control room mix and the LED meters won't light up.

The "CTRL RM" in the name of this knob refers to the fact that it controls the signal that typically is sent to the control room monitors of a studio, where someone—usually an engineer—is working the mixer. However, don't be intimidated if you're using this mixer in your bedroom, which probably isn't equipped with a control room. In this scenario, you can use headphones or connect the CTRL RM OUT to your speakers.

When you solo a channel via its PFL / SOLO switch, that channel's signal will override your control room mix selection. You then will hear only that channel in the control room and the headphones.

MIX Switch

Pressing the MIX switch routes the main mix to the control room level control. When you engage this switch, the channels and aux sends will pass through the MAIN MIX fader and then through the HDPH / CTRL RM level control. You can then keep the MAIN MIX fader set to unity gain for optimal recording, and the HDPH / CTRL RM level control set to a more comfortable listening level if necessary.

ALT 3/4 Switch

When you press the ALT 3/4 switch, the signal from the ALT 3/4 stereo mix bus is routed through the HDPH / CTRL RM level control.

2TK Switch

If you want to monitor the signal coming in from the 2-TRACK jacks and from the computer (if a Firewire cable is attached), press the 2TK switch.

Aux Ret A Level

This is the level control for the signal returning to the mixer via AUX RETURN A.

Effects / Aux Ret B level

If you are using one of the MultiMix's internal effects, this knob controls the effect level. If AUX SEND B is connected to an external device, this knob controls the level for AUX RETURN B.

LED Meters

These are the two rows of yellow, green and red lights you see in the master section of the mixer. They are very versatile, allowing you to view the signal level of the main mix, individual channels (both pre- and post-fader) and aux returns depending on which signal you have routed to the control room mix.

POWER Indicator

When this LED is lit up, that means the POWER ON switch on the rear of the mixer has been activated.

+48V Indicator

When this one is lit up, that means the PHANTOM ON switch on the rear of the mixer has been activated and is supplying +48V phantom power to all XLR mic inputs.

Rear of the Mixer

Here's what you'll find at the rear of the mixer.

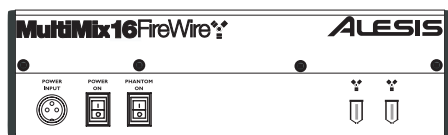

Rear

Power Input

Here's where you plug in your mixer's external power supply. You should always connect your power supply to the mixer *before* you plug the power supply into an electrical outlet.

Power Supply Unit

This unit provides 18.5 VAC at 700 mA of power, more than enough to keep your MultiMix running smoothly. As with nearly all power supply units, this one tends to get warm when left on for a while. This is perfectly normal.

*The POWER INPUT is built to accept **only** the power supply unit provided with your MultiMix, or an AC power supply that has the same specs. Others probably will not work.*

Power On

Another easy one. Switch this one on and your mixer has power. Switch it off and it doesn't. Make sure the faders in the master section are pulled all the way down when powering your mixer up or down.

Phantom On

This switch activates and deactivates the phantom power described in "Mic Inputs (Channels 1 – 4)," page 13. This switch controls phantom power for all four mic inputs.

*As we said earlier, it's very important that you plug in your microphones and mute your system **before** you turn on phantom power.*

Firewire ports

These ports allow you to connect the MultiMix to a computer for multichannel digital audio communication. Use one port to connect to a computer; the other port can be used for other computer peripherals (like external hard drives).

3 Digital Effects Processor

Onboard your MultiMix FireWire is a powerful effects unit that has 100 preset programs. We offer a few tips on where to use these, but don't limit yourself to our suggestions. We recommend that you experiment with these effects to get a good feel for how they can improve your mixes

Effects Section Components

Program Selection Knob

You can use this knob to assign one of 100 effect programs to your mix. Turning the knob to the right increments the program number, and turning it to the left decrements the program number. You can control the level of the effect for each channel via the channel's AUX B knob. You must PRESS the effect knob to activate the selected effect.

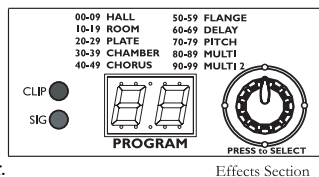

LED Display

This display shows you the number of the current program.

CLIP Indicator

When lit, this LED tells you that there is a signal clip at the internal effects input. This means that you should reduce the signal via the EFFECTS / AUX RET B LEVEL control.

SIG Indicator

When lit, this LED indicates that the effects processor is receiving a signal.

Effect Descriptions

HALL

This type of reverb simulates the ambience of a grand concert hall.

ROOM

This type of reverb reproduces the more intimate ambience of natural room acoustics.

PLATE

These are simulations of metal plate reverbs, as used on classic recordings from the '70s and '80s.

CHAMBER

These are simulations of the reverb created by artificial echo chambers, as used on classic recordings of the '50s and '60s.

CHORUS

These create the effect of multiple voices (or instruments) sounding at once from a single input.

FLANGE

These create a sweeping, swooshing sound effect that you will probably recognize.

DELAY

These effects are based on a discreet repetition or echo of the input.

PITCH

These effects transpose the pitch of the input signal and blend the effect signal with the original to create harmonies.

MULTI & MULTI II

These are combinations of two or more of the above effects.

4 Traditional Mixing

Simple Live Setup

Connect your instruments and microphones to the mono and stereo channels, making sure to properly set the level of each channel.

You can select one on-board effect and control its level with the AUX B knob for each channel. You can also use an external effects processor by sending a signal to the external unit via the AUX SEND A and returning it via AUX RETURN A (you'll probably want to set AUX SEND A to POST, for "post-fader").

If you wish, you can use a second external effects processor via AUX SEND B and AUX RETURN B. However, note that use of an external effects processor on these jacks disables the internal effects.

Connect the MAIN MIX OUT to a PA system amplifier. For monitoring purposes, you can connect the CTRL RM OUT to a headphone amplifier. You could also connect a digital equalizer (like the Alesis DEQ-230D) between the DIGITAL OUTPUT and a PA system for extra tone control.

By muting channels and pressing the ALT 3/4-to-HDPH/CTRL RM button in, you can audition a channel before you bring it into the mix, making sure the levels are OK before the audience hears it.

Using Additional External Audio Sources

The MultiMix gives you a few extra audio inputs in addition to the mic and line inputs. If you want to bring external audio sources into a recording or live mix, you can do it in one of two ways:

Using the 2-TRACK IN, you can add a tape deck, ADAT, CD player, Firewire audio stream from a computer, or other source to the mix. The 2-TRACK IN also can be used to entertain the audience with a CD as the band is setting up for a live show.

The AUX RETURNS can be used as additional audio inputs when you are not using them for effects.

S/PDIF digital output to a digital recorder

Connect the S/PDIF DIGITAL OUTPUT of your MultiMix console to the DIGITAL IN on your external digital recorder (12-channel and 16-channel models only).

Audio coming into the MultiMix from a computer over the Firewire connection is routed to the 2-TRACK IN.

You can use the RCA jacks of the 2-TRACK IN at the same time as audio is playing back from a computer, but you must adjust the relative levels of each input from outside the MultiMix.

The S/DPIF output operates at 24 bits. This is compatible with devices like CD recorders that operate at 16 bits: the least significant bits are simply ignored by the 16-bit device.

5 Traditional Mixing

This page intentionally left blank.

5 Firewire Recording

Important: download the drivers from <http://www.alesis.com> onto a folder on your desktop or insert the software CD into your computer's CD drive BEFORE you plug your MultiMix into your computer for the first time.

First-time connection instructions and driver installation

Important: Follow these steps BEFORE you plug in your MultiMix FireWire mixer for the first time.

If your computer has access to the Internet, point your browser to the Support > Downloads section of <http://www.alesis.com>. It's possible that updated drivers have been posted there since the time the software CD included with your MultiMix was printed.

Using either drivers from the website or the software CD, connect your MultiMix FireWire to your computer and turn the MultiMix FireWire on.

Windows

Under Windows XP, the "Found New Hardware" wizard will run. You will be prompted to install a series of drivers.

If you downloaded the drivers from the Internet, choose to install the drivers from a specific location when prompted, and point to the folder that contains the drivers.

If you are using the drivers from the CD, choose to install the drivers automatically when prompted.

For each of the several installations that occur, click "Continue Anyway" if Windows warns you that the drivers have not passed Microsoft Logo Certification.



Windows Logo Certification warning. Ignore this warning by clicking "Continue Anyway."

Your MultiMix Firewire mixer requires several sets of drivers to work properly. The installation process will automatically install these drivers one by one. Let the installer continue installing the various sets of drivers until the you see a message stating, "Your

These drivers include the two most popular standards for audio interfacing—WDM (the "Windows Driver Model" built by Microsoft) and ASIO (the "Audio Stream Input/Output" standard used by many audio software applications).

new hardware is installed and ready to use.” Do not cancel any of the installations, as they are all required for proper operation.

Macintosh

Mac driver installation is more straightforward, as only CoreAudio drivers are installed. Simply double-click the installer program to install the drivers.



Mac OS X 10.3 or higher is required by the MultiMix drivers.

Installing the optional applications

The software CD that comes with the MultiMix FireWire contains not only the *drivers* (the small computer programs that work behind the scenes so that your MultiMix works properly with your computer) but also some powerful music *applications*.

If you don't already have a Digital Audio Workstation (DAW) program, definitely install the one provided on the CD. It's a fantastic way to get started in computer-based recording. You may find that it's the only program you need.

The demo applications give you a taste of some of the premier computer-based music programs on the market today. We encourage you to install and explore them.

Power-on/Power off order

To ensure that the MultiMix is recognized correctly by your computer, follow these instructions for powering on and off your equipment:

Power-on sequence

1. Connect mics and line-level sources to the MultiMix.
2. Connect the MultiMix to the computer using the Firewire cable.
3. Turn on the MultiMix. Wait a couple of seconds.
4. Turn on the computer.

Power-off sequence

1. Turn off the computer. Wait for the computer to shut down entirely.
2. Turn off the MultiMix.

All digital audio carried over the Firewire connection is 24-bit PCM data. (Digital audio sent through the S/PDIF output is 16 bit—the standard bit rate for CD audio.)

If you have a notebook computer with a mini-Firewire connection, use a 4-pin to 6-pin Firewire cable (not included) to connect to the MultiMix FireWire.

You can use either of the two Firewire ports on the back of the MultiMix. The other port can be used to attach another Firewire-based computer peripheral, such as an external hard drive.

Firewire inputs and outputs

Channels sent from the MultiMix to the computer

The Firewire port sends every individual mixer channel as well as the MultiMix's MAIN OUT/2-TRACK OUT left and right signals to the computer. This means that, for the MultiMix 12 FireWire, 12 individual channels are sent to the computer along with the MAIN stereo pair (14 channels in total.) For the MultiMix 16 FireWire, 16 individual channels are sent to the computer along with the MAIN stereo pair (18 channels in total.)

Individual channels

The INDIVIDUAL channels sent to the computer send the signal after the preamp gain knob, the high-pass filter, the three-band EQ, and the channel fader.

The effects of the AUX send knobs are NOT included in the outputs of the individual channels.

MAIN MIX channels

The MAIN mix channels sent to the computer exactly mirror the MAIN output of the mixer. If you are only interested in making stereo recordings, consider recording the MAIN channels in your recording software.

Channels returned from the computer to the MultiMix

The Firewire port receives a stereo audio stream from the computer and assigns it to the 2-TRACK IN left and right channels of your MultiMix mixer. Note that, if a device is connected to the MultiMix's 2-TRACK IN inputs, the signal from this device is merged with the signal from the computer.

To understand why the AUX signals are not blended into the individual channel feeds to the computer, consider the nature of AUX sends:

Every channel can send none, some, or all of its signal to the AUX processors. For instance, in the MultiMix 12, 12 different signals could be sent to an external processor, all at different levels.

However, that AUX processor can only return at most a stereo pair into the mixer. There's no way that the processor could route the effects of each channel back to that channel directly without including the signal from the other channels as well.

Sound setup under Windows

To use your MultiMix FireWire as your default Windows sound device, follow these steps:

1. From the Windows Start menu, choose “Control Panel.” Depending on your Windows preferences, it will appear similar to one of the two pictures below:

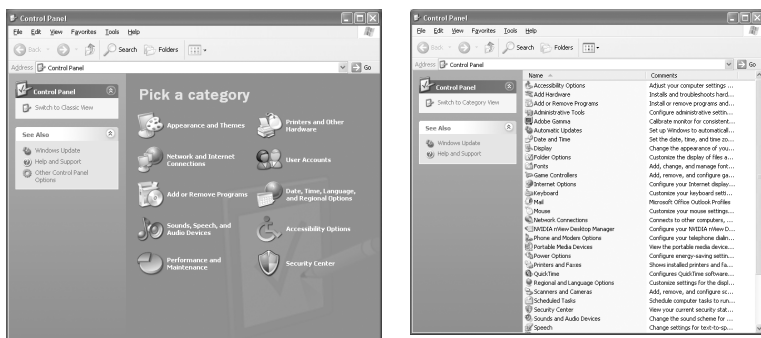

2. Choose “Sounds and Audio Devices”.
3. Click the “Audio” tab. Change the default devices for both sound playback and sound recording to the MultiMix. (For sound recording, choose the “MultiMix Main” option.)

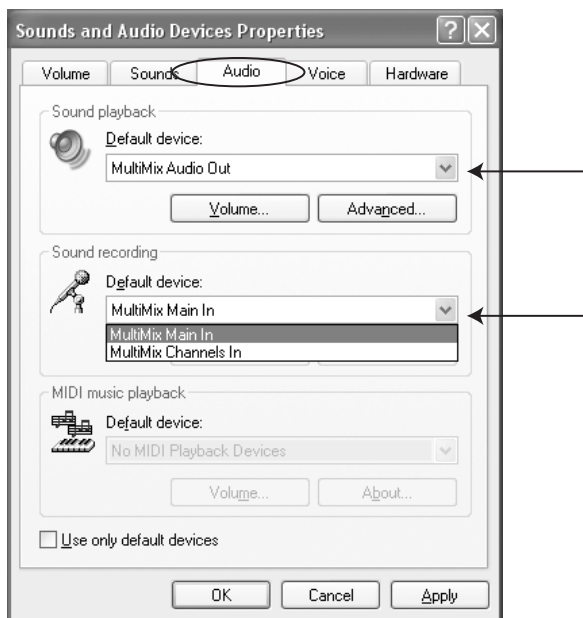

- Click the “Voice” tab. Change the voice playback and voice recording settings to the MultiMix. For voice recording, you may choose either the “MultiMix Main” or the “MultiMix Channels” option.

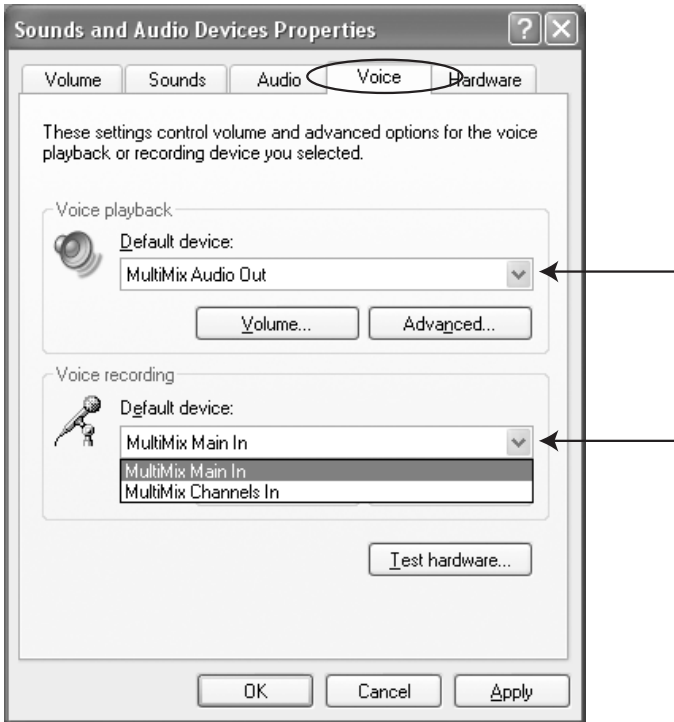

- Click “Apply” to apply these changes.

Disabling Windows System Sounds

Windows System Sounds—the sounds that Windows plays to signal starting up, shutting down, alerts and so forth—can interfere with your audio recording. We **strongly suggest** that you disable these sounds.

1. Click the “Sounds” tab of “Sounds and Audio Devices.”
2. Under “Sound Scheme,” choose “No sounds.”

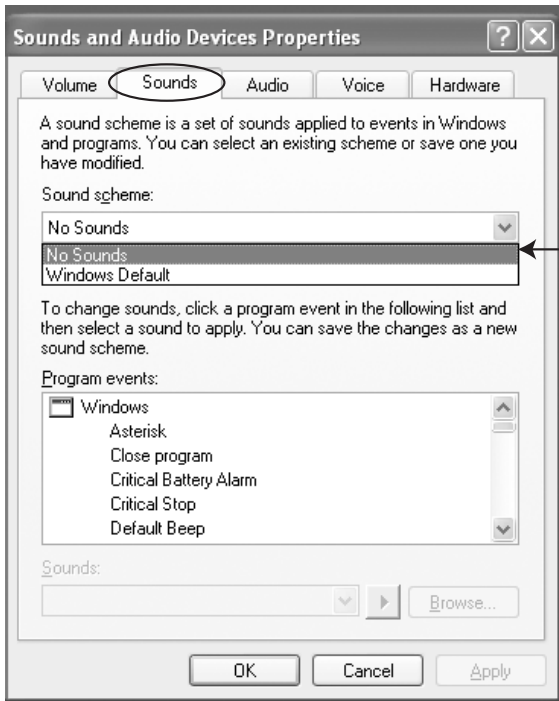

3. Click “OK” to accept this entry and close the dialog box.

Connections and settings for Firewire recording and monitoring

The best way to begin using the MultiMix for Firewire recording is to set up your system this way:

1. Hook up your monitoring system to the MultiMix's CTRL RM OUT jacks.
2. Apply the MASTER section's buttons as follows:
 - a. **2 TK TO MIX: Leave UP.**
Pressing this button down can cause nasty feedback loops.
 - b. **MIX TO CONTROL ROOM: Press DOWN.**
This will allow you to hear the music being recorded in real time.
 - c. **ALT 3/4 TO CONTROL ROOM:**
Leave up or down.
 - d. **2 TK TO CONTROL ROOM: Press DOWN.**
This will allow you to hear the output from the computer.
 - e. **ALT 3/4 TO MIX:** Leave up or down.

Using the MultiMix FireWire with Cubase and other ASIO applications

Audio recording programs running on Microsoft Windows generally use one of two different audio standards—WDM (the “Windows Driver Model,” developed by Microsoft) or ASIO (“Audio Stream Input/Output,” developed by Steinberg and made freely available to other companies).

Audio on the Macintosh (OS X) generally runs on top of Apple's CoreAudio standard.

We'll look at how to use the MultiMix FireWire under each of these standards, starting with ASIO (using Cubase as an example).

Choosing the MultiMix as your audio device

1. Choose the menu option “Devices” | “Device Setup...”

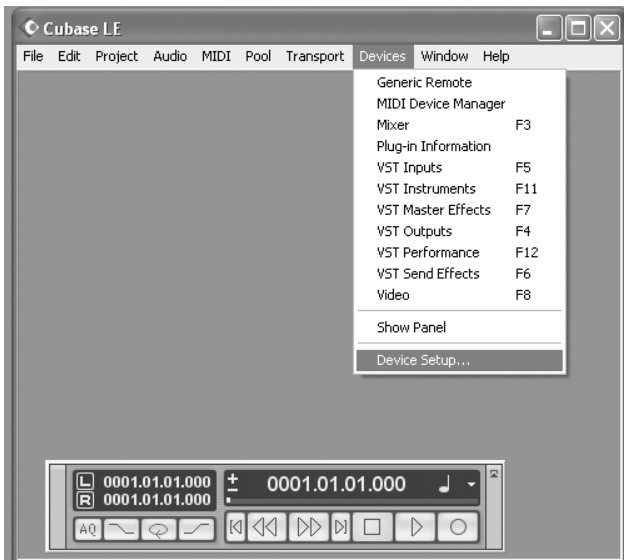

This discussion uses Steinberg's Cubase software, but the principles provided here apply to all ASIO recording software.

2. Click the “VST Multitrack” option.

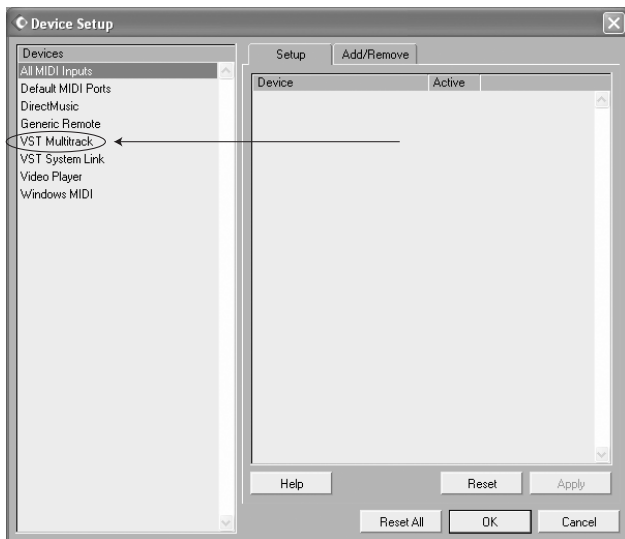

- From within the ASIO Driver drop-down box, choose the MultiMix.

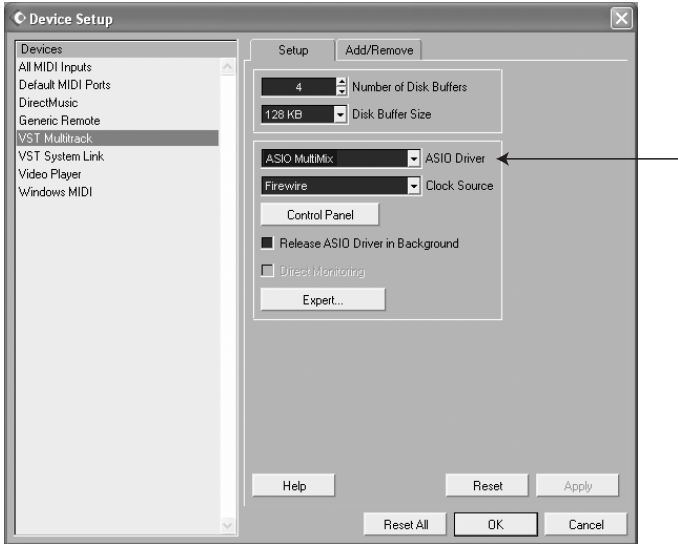

- Press “OK” to accept this setting.

Different versions of Cubase function similarly, but not exactly, to the examples shown here.

- Now that the MultiMix is selected as the audio device, individual channels must be activated for use. Again, return to the “Devices” menu, and select “VST inputs.”

Some versions of Cubase do not allow all inputs to be used simultaneously.

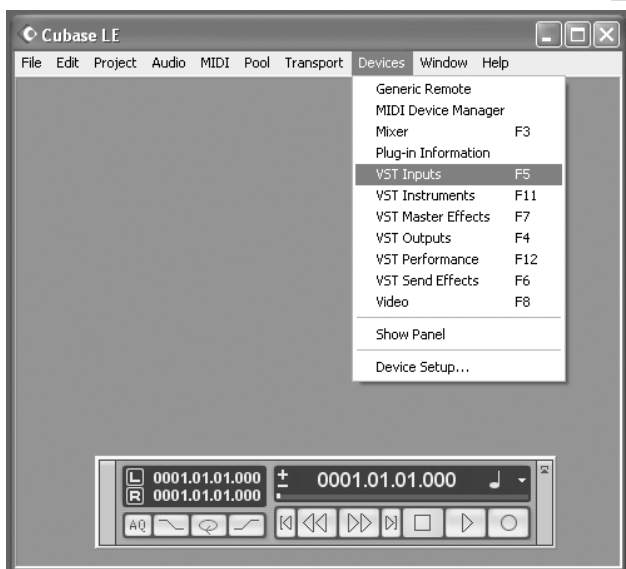

- Click the activation buttons for channel pairs that you want to use.

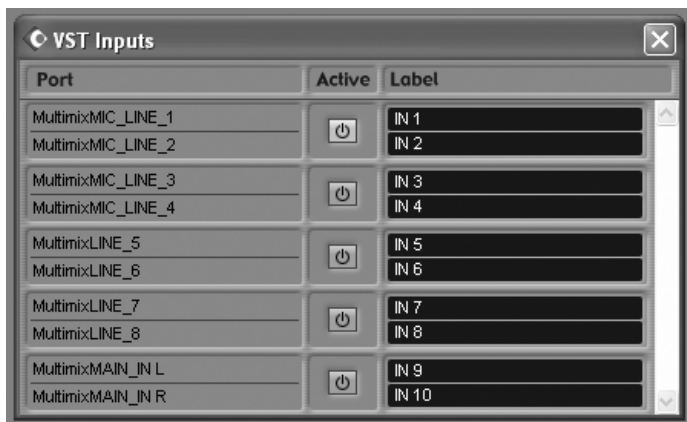

7. In Cubase, you can rename channels by clicking in the “Label” area. This is useful if, for instance, your lead vocals are always on channel 1, your bass drum is always on channel 2, etc.



Creating a new audio file

Now, you're ready to create an audio project.

1. Choose "File" | "New Project..."

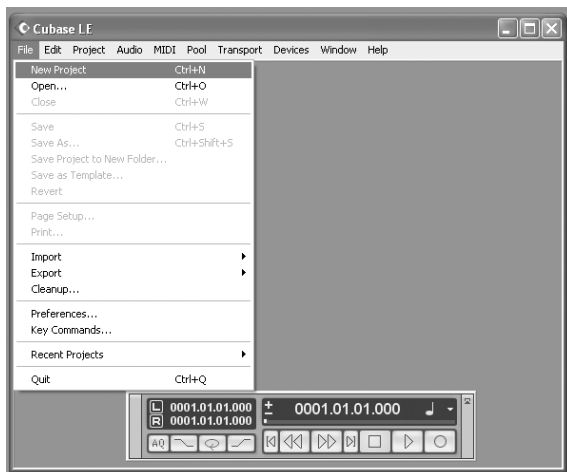

2. You can begin with a template or an empty file. For now, begin with an empty file.

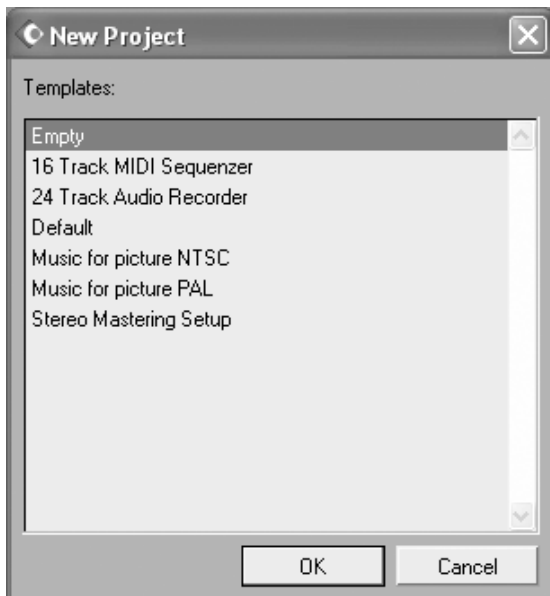

3. Cubase needs to know where to place audio. Choose a directory here.



An excellent scheme for storing your projects is to create a directory called "audio projects." Then, within that folder, create a new folder for each song you work on. Cubase will store your song file and all associated audio files in that same folder.

4. Now, you have a blank project. Add an audio track for recording by choosing "Project" | "Add Track" | "Audio."

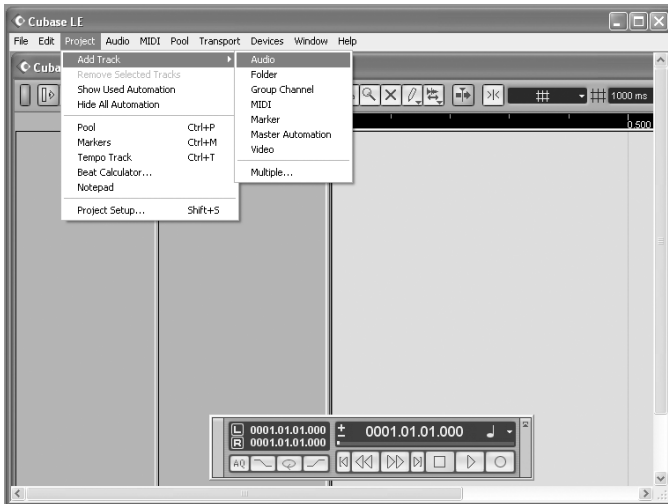

- Be sure that the “inspector”—a strip on the left-hand side of Cubase that shows all sorts of information about the selected track—is active.

If your view is similar to that shown below, the Inspector is active. If you do not see all of the information on the left-hand side, the Inspector is not active. To activate it, press the “show Inspector” button towards the upper left of the screen (just below the “Edit” menu in the following picture).

Later, you can hide the Inspector if you want to save space on your screen.

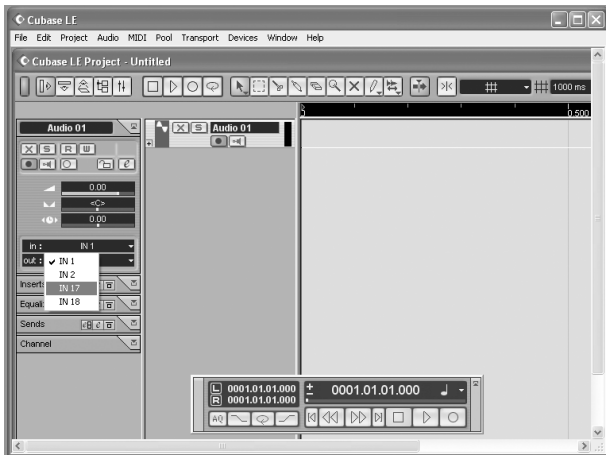

- Choose an input for your track by selecting it from the “in” area on the left. To record stereo on the track, click the button highlighted below.

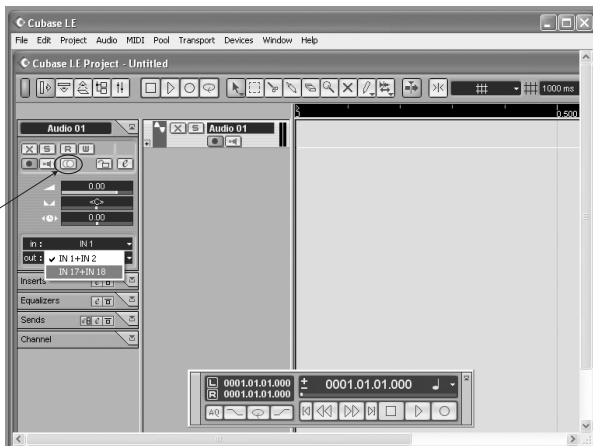

- You will do most of your monitoring through the mixer. However, if you want to monitor with Cubase's effects, or if you just want to hear what the computer is hearing, press the direct monitoring button next to the Record Enable button.

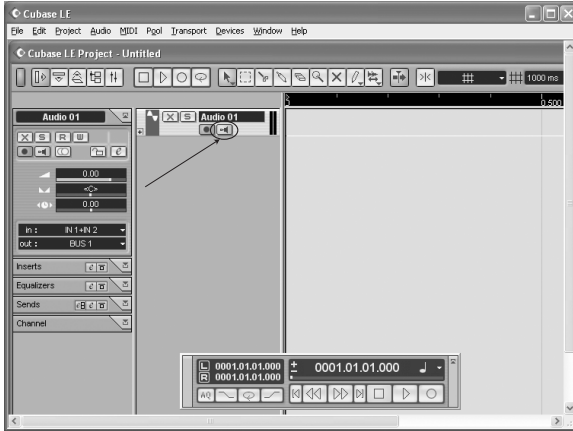

Note that using direct monitoring causes a small delay as the digital audio is being processed. For this reason, when you use direct monitoring, you may want to press the MultiMix's **MIX TO CONTROL ROOM** button up so as not to hear the audio signal twice.

- Add additional audio tracks as needed. Record-arm each one and press the RECORD button to begin recording.

For additional information, consult your software's documentation.

Working with the ASIO control panel

Accessing the ASIO control panel

From within Cubase, select “Devices” | “Device Setup...” | “VST MultiTrack.” Then, click the “Control Panel” button to access the MultiMix’s ASIO control panel.



Setting the mixer nickname

You can change the name of the mixer as it's seen by the recording program. Once this is done, choose “Reset All” in Cubase (or the equivalent command in other programs) to make the change to the mixer down flow down to the names of the input and output channels.

Setting the master device

If multiple audio devices are connected, one must be designated as the clock master.

Adjusting latency by changing the buffer size

“Latency” refers to the amount of time it takes for audio to get into and out of the computer. In the best of all possible worlds, there would be no such thing as latency—we would hear audio the moment it was created. However, computers have limited processing power, and they can “choke”—cutting off recording or crashing programs—if they are asked to handle too much data all at once.

To minimize this risk, audio can be stored in a buffer for a certain amount of time. This buffering helps smooth out the stream of data that the computer needs to handle. In the end, all of the audio is sorted out and played correctly, but with a delay.

Here are the basic considerations to consider when adjusting buffer sizes:

Lower buffer size = less latency but higher risk of audio problems

Higher buffer size = more latency but lower risk of audio problems

Very high buffer size = possible system instability

For most systems, there is a “sweet spot” where latency is not too high and system performance is good. Experiment with raising or lowering buffer sizes to hit this sweet spot.

As you begin adding plug-in EQ, compression, and so forth to your project, your computer will need to work harder. If you start to hear clicks, pops and other glitches in your audio, consider increasing your buffer size at this time.

As a final note, one tremendous benefit that the MultiMix FireWire offers is that you can monitor through it without latency at all. Simply press down the **MIX TO CTRL ROOM** button, and you can hear what you’re recording without having to worry about your computer’s settings.

Adjusting the sample rate

You can change the sample rate that the MultiMix uses in this area.

Some audio programs require that you change the sample rate under their Project Setup or similar menus as well. For instance, in Cubase, be sure that the sample rate selected here matches the settings under the “Project” | “Project Setup...” menu.

Many people use two latency settings—a lower one when recording tracks and a higher one when mixing.

Using the MultiMix FireWire with Sonar and other WDM applications

Choosing the MultiMix as your audio device

1. Choose the menu “Options” | “Audio...”

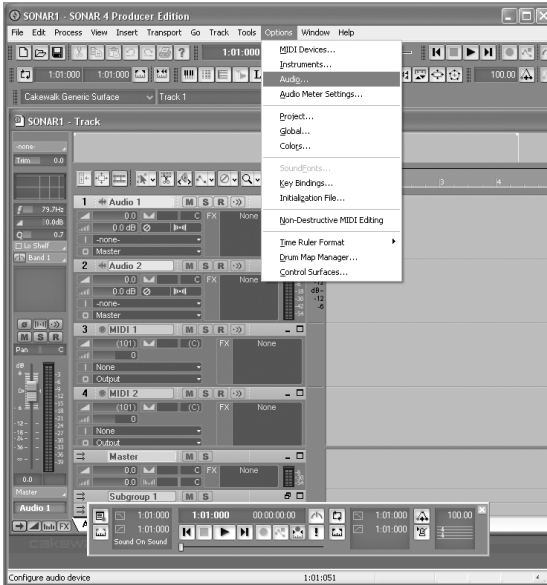

Choosing the MultiMix as your audio device Unlike ASIO, WDM allows multiple audio devices to be used at the same time. However, doing so can cause all sorts of synchronization problems. Therefore, we suggest that you use the MultiMix as your sole audio input/output device.

2. On the “General” tab, select any available MultiMix channels as the Playback and Record timing masters.

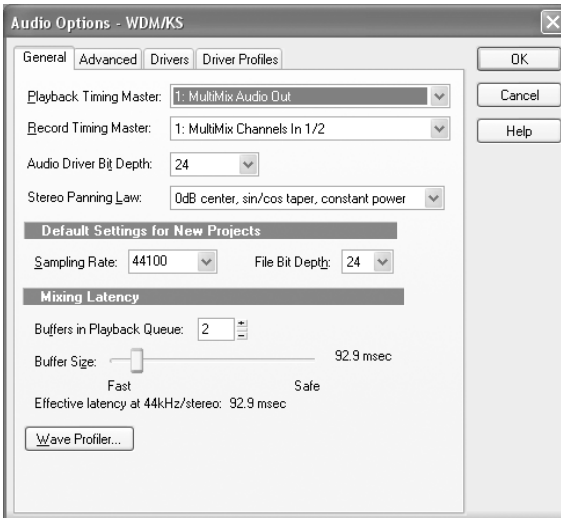

This discussion uses Cakewalk's Sonar software, but the principles provided here apply to all WDM-based recording software.

3. Click the “Advanced” tab. For WDM operation, be sure that the “Driver Mode” is set to “WDM/KS.” (If you change this setting, you will need to exit and then restart Sonar.)

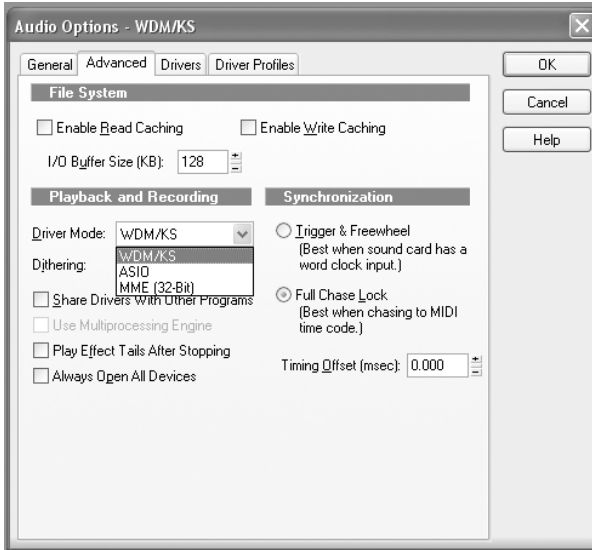

For applications like Sonar that support both WDM and ASIO modes, you may want to experiment with each to see if either mode offers greater stability.

4. Move to the “Drivers” tab. Click on each input pair and also on the output pair to make them available to Sonar.

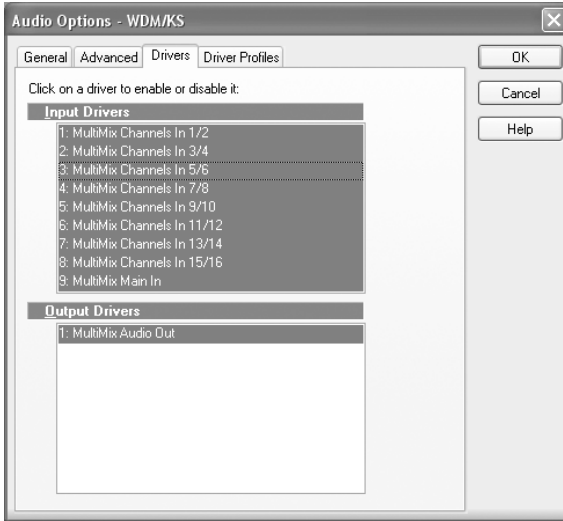

Assigning inputs to audio tracks

Now, you're ready to assign the MultiMix's inputs to various channels.

For each audio track that you want to record, click on the input section of the track and select the MultiMix channel that you want.

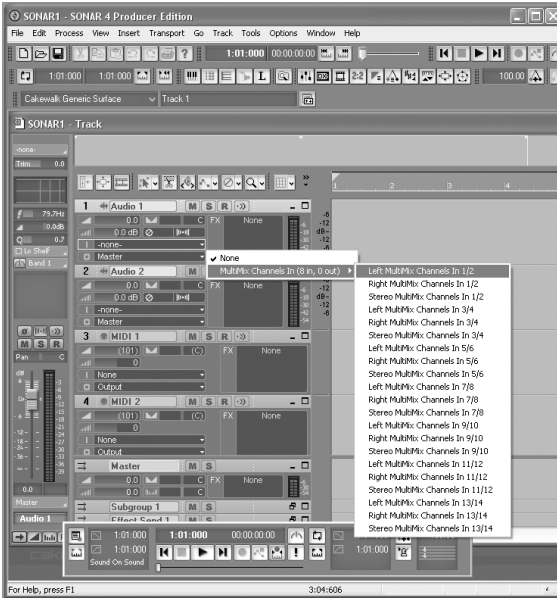

Record-enable the tracks to be recorded (first arrow).

You will do most of your monitoring through the mixer. However, if you want to monitor with Sonar's effects, or if you just want to hear what the computer is hearing, press the direct monitoring button next to the Record Enable button (second arrow).

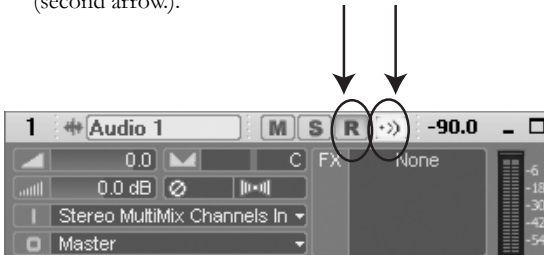

Note that using direct monitoring causes a small delay as the digital audio is being processed. For this reason, when you use direct monitoring, you may want to press the MultiMix's **MIX TO CONTROL ROOM** button up so as not to hear the audio signal twice.

Using the MultiMix FireWire with CoreAudio on the Macintosh

Mac users can impress their friends with the following instructions for using the MultiMix with CoreAudio:

1. Open the Mac's "Audio MIDI Setup" utility.
2. Choose the MultiMix FireWire as both input and output device.
3. Choose the MultiMix as the default input and output.
4. Under System Preferences, choose "MultiMix FireWire." Adjust the device nickname, buffers, clock source, sample rate, etc. as needed. For additional information on these settings, see the discussion of the ASIO control panel on page 40.



Mac OS X 10.3 or higher is required by the MultiMix drivers.

6 Troubleshooting: non-Firewire

If you're having problems operating the MultiMix, this troubleshooting index will help you correct them.

Symptoms	Cause	Solution
No sound from the mixer.	Mixer is not plugged in or turned on.	Plug in mixer and turn it on.
	Faders are too low.	Raise appropriate faders.
	Control room level is too low.	Turn up control room level.
	The appropriate signal hasn't been assigned to the control room out.	In the master section of the mixer, be sure the right switch is selected (MIX, ALT 3/4 or 2TK).
	Cable is not plugged into output jack.	Check outputs to make sure cables are plugged in securely.
	Headphones are not plugged into PHONE jack.	Plug headphones into PHONE jack.
	Monitor or headphone amplifier is turned off or down.	Turn amplifier on or up.
Audio signal is distorted.	Bad cable.	Check all cables; substitute cables with known good ones.
	Channel level is too high.	Set channel levels using the procedure on page 12.
	Channel input is too high.	Turn down your instrument to a normal volume and then set channel levels using procedure on page 12.
	AUX RET B level is too high.	Lower the level of AUX RET B in the master section of the mixer.
	MAIN MIX level is too high.	Lower the MAIN MIX fader in the master section of the mixer.
	ALT 3/4 level is too high.	Lower the ALT 3/4 fader in the master section.

6 Troubleshooting: non-Firewire

Audio signal carries an unwanted hum.

Too much low-level noise in the mix.

Engage the channel's high-pass filter by pressing the HPF switch.

Interference from appliances such as air conditioners.

Engage the channel's high-pass filter by pressing the HPF switch.

Not using TRS cables.

Make sure you are using 1/4" TRS cables.

Microphone level is too low.

Phantom power is not turned on.

Turn on phantom power using the switch on the rear panel of the mixer.

Microphone is damaged.

Test the microphone on other audio devices. If you detect damage, contact the manufacturer or dealer.

No or low sound from a channel.

Fader is too low.

Raise channel fader.

Instrument volume is too low.

Turn up the instrument's volume control. If problem persists, check the instrument by plugging headphones into the instrument's phone jack.

Channel is muted.

Check the MUTE / ALT 3/4 switch.

Gain is too low.

Adjust the channel's GAIN control.

Internal effects aren't working.

Effects level is too low.

Turn up the level using the EFFECTS / AUX RET B LEVEL control in the master section of the mixer.

An effect hasn't been selected.

Press the EFFECTS knob on the desired effect and make sure the SIG indicator is lit.

<p>External effects aren't working.</p>	<p>Effects processor is not plugged in or turned on.</p>	<p>Make sure unit is plugged in and turned on.</p>
	<p>Aux outputs of mixer aren't connected to inputs of processor or processor's outputs aren't connected to mixer's inputs (or aux return).</p>	<p>Make sure the mixer's aux outputs are connected to the processor's inputs and that the processor's outputs are connected to the mixer's aux inputs.</p>
	<p>Mixer's effects return signal is too low.</p>	<p>Turn up the output of the effects processor or turn up the mixer's AUX RET A RETURN or EFFECTS / AUX RET B RETURN in the master section.</p>
<p>LED meters not working.</p>	<p>Nothing is routed to the HDPH/CTRL RM output.</p>	<p>Press the desired MIX, ALT ¼ or 2 TK button.</p>
<p>Computer does not see the MultiMix.</p>	<p>FIREWIRE connection must be established.</p>	<p>Unplug the FIREWIRE cable and turn off the MultiMix. Turn the MultiMix back on and plug the cable back in. If this does not work, leave the MultiMix on, turn off the computer (do not use "restart" but instead actually turn off the computer) and then turn it on again.</p>
<p>Computer sees the MultiMix FireWire, but no sound is received and/or transmitted.</p>	<p>MultiMix FireWire is not set as primary sound device.</p>	<p>In the computer's Control Panel, go to the Sounds/Multimedia area. In the Audio section, set the default sound recording and playback devices to MultiMix FireWire.</p>
<p>Firewire audio has crackling or glitches, or audio plays/records at incorrect pitch.</p>	<p>Computer configuration may be incompatible with Firewire audio.</p>	<p>Certain Firewire chipsets have design limitations or IRQ assignment restrictions that must be resolved before audio can work correctly on them. See your Firewire chipset documentation for further information if required.</p>
<p>No power.</p>	<p>Incorrect or defective power supply.</p>	<p>Replace with correct power supply (only use Alesis-recommended AC output power supply).</p>

This page intentionally left blank.

7 Troubleshooting: Firewire

Computer or audio application does not see the MultiMix FireWire

Basic troubleshooting

First, check that the MultiMix is seen by the computer: Under “Sounds and Audio Devices” (Windows) or “Audio MIDI Setup” (Mac), look for the MultiMix FireWire to be listed as an available device.

If the MultiMix FireWire is not seen, check that the Firewire cable is properly connected. Power the MultiMix FireWire off, wait a few seconds, and then power it on again. Repeat this process until the MultiMix FireWire is found.

For instructions for checking on this basic connectivity, see page 28 (Windows) or page 36 (Macintosh).

Advanced troubleshooting under Windows

The best way to see that your MultiMix is connected and operating properly is through the Windows Device Manager. This is a powerful Windows component that requires some navigation but yields very detailed information.

1. Start by finding the “My Computer” icon either on your desktop or from the Start menu.



2. Right-click the “My Computer” icon and select “Properties.”

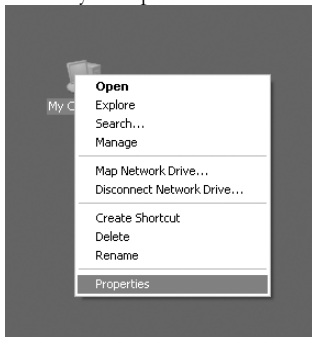

3. The active tab at the top of this window is now the “General” tab. Click the “Hardware” tab. Then, click the “Device Manager” button.

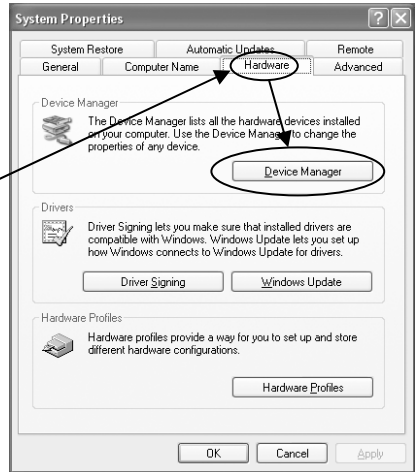

4. Finally, expand the “Sound, video and game controllers” section. “MultiMix Audio” should appear.

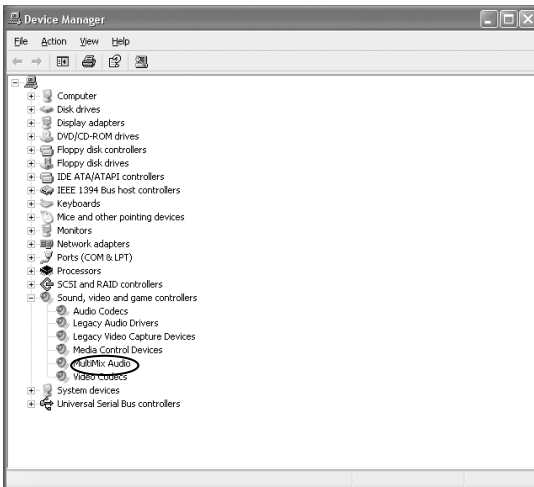

No connection

If “MultiMix Audio” does not appear, Windows does not see the mixer as being connected to the computer. Check your Firewire cable and try powering the mixer off and on again.

Expand the “IEEE 1394 Bus host controllers” section. Check that your Firewire card is listed as properly working.

As a last resort power your computer off and on.

Faulty connection

If “MultiMix Audio” appears, but there is a yellow question mark or exclamation point attached to it, the drivers are improperly installed. Right-click on the MultiMix Audio listing, choose “Uninstall...”, and uninstall the device. The next time you connect the MultiMix to your computer, you will need to re-install the drivers from scratch.

When restarting your computer, turn it off all the way. Pull out the AC power cord, keep it out for a few seconds, and then plug it back in again before you restart your computer.

This step helps reset your computer’s PCI cards, including any Firewire cards.

Audio playback or recording is at the wrong speed

Adjust the buffers in the ASIO control panel or through your WDM application’s audio setup options.

It is impossible to say which buffer settings are perfect for each system, but generally buffer sizes around the middle or low-middle of the available range provide the best results.

Audio playback or recording stutters or drops out

Again, work with the buffer settings in the ASIO control panel or through your WDM application’s audio setup options in order to find the most reliable setting.

Many audio applications include advanced setting dialog boxes where pre-fetch and other parameters can be set. Explore those options.

Help on the web

Most major recording programs are supported by lively user forums. The odds are that, if you’re having problems, someone who posts at these forums has already experienced them and found solutions.

Audio echoes during recording

Either turn your software direct monitoring off or—if you want to monitor your incoming audio through your software—put the **MIX TO CTRL RM** button in the UP position.

Don’t be shy about visiting these forums and posting your questions.

Be sure to attach your monitoring speakers to the CTRL RM OUT jacks, not the MAIN MIX OUT jacks.

7 Troubleshooting: Firewire

This page intentionally left blank.

Specifications

For the more technical-minded, here are some detailed specifications for the MultiMix's operating levels.

Input Channels

Mic In Sensitivity Range:	-60dBu to -10dBu nominal, +5dBu maximum
Line In Sensitivity Range:	-40dBu to +10dBu nominal, +25dBu maximum
Mic/Line Gain Range:	+10 to +60dB

Equalization

High-Pass Filter:	75Hz, 18dB/octave
High Shelving:	12kHz, +/- 15dB
Mid Bandpass/Band Reject:	2.5 kHz, +/- 15dB
Low Shelving:	80Hz, +/- 15dB

Aux Sends

Aux Send A & B Gain Range: $-\infty$ to +10dB

Aux Returns

Aux Return A Gain Range:	$-\infty$ to +15dB
Effects Level/	
Aux Return B Gain Range:	$-\infty$ to +15dB

Channel Levels

Channel Level Gain Range: $-\infty$ to +10dB

Master Levels

Main Mix, Ctrl Room Gain Range: $-\infty$ to +10dB

1/4" Inputs

Stereo Aux Return Level: +4dBu nominal, +20dBu maximum

RCA Inputs

2-TRACK IN Level: -10dBV nominal, +5dBV maximum

1/4" Outputs

Main Mix, Ctrl Room, Aux 3/4, Ext Aux Send Level: +4dBu nominal, +20dBu maximum

Headphone Output: 75 ohm output impedance
>105mW into 75 ohms, >40mW into 600ohms

RCA Outputs

2-TRACK OUT Level: -10dBV nominal, +5dBV maximum

S/PDIF and Firewire digital outputs

Bit depth: 24 bit
Sample rate: 44.1kHz, 48kHz (switchable in software)

All measurements done over a 22Hz – 22kHz range with a 1kHz sine wave at +18dBu (-1dBFS) input. Impedances are measured at 1kHz.

Mechanicals**(W x L x H)**

MultiMix 12 FireWire:

13.0" x 13.4" x 3.2" /
331mm x 340mm x 80mm,
7.0lbs / 3.2kg

MultiMix 16 FireWire:

13.0" x 15.2" x 3.2" /
331mm x 386mm x 80mm,
9.7lbs / 4.4kg

**ALESIS
12-CHANNEL ANALOG MIXER w/ DIGITAL OUT**

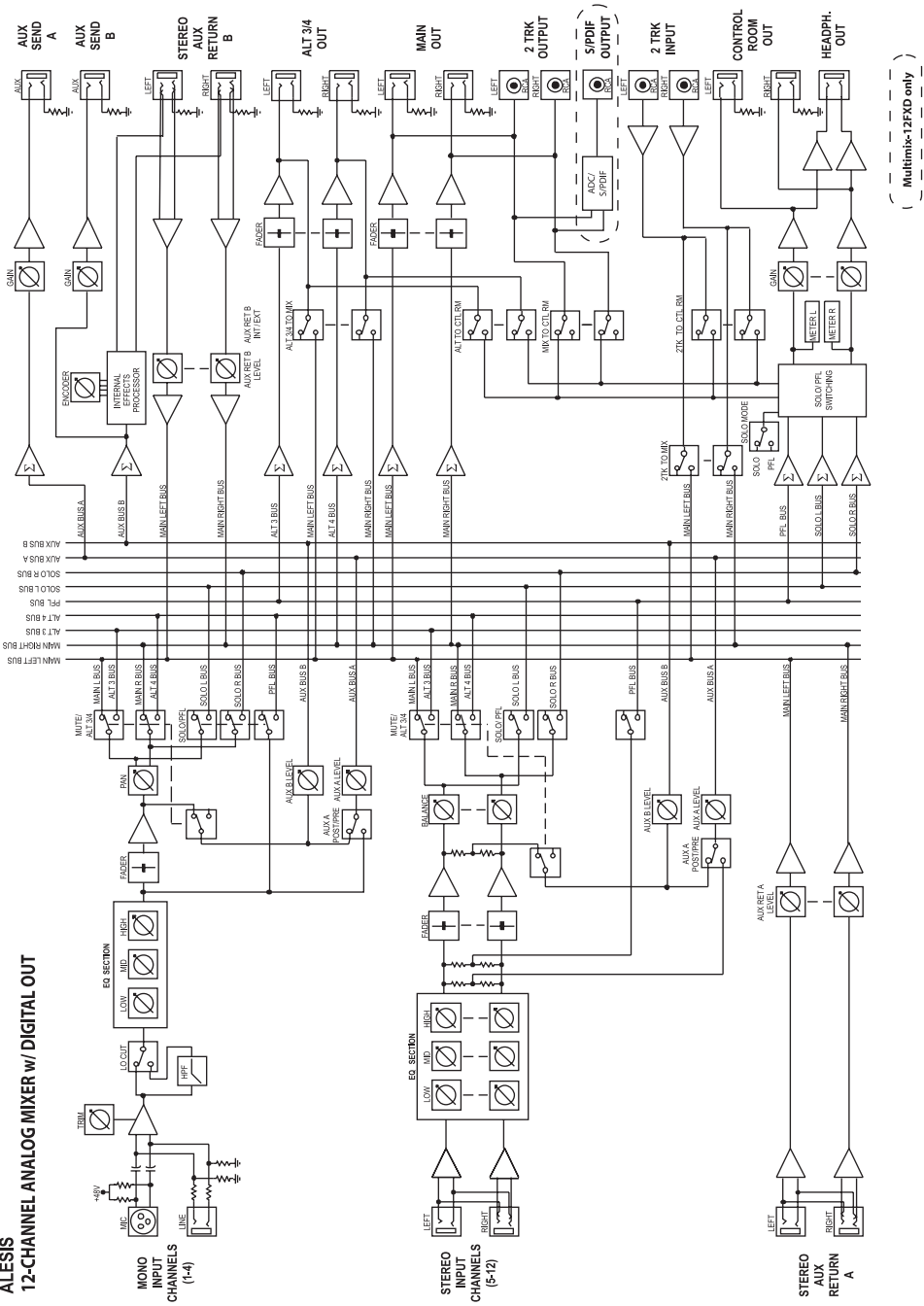

ALEXIS

16-CHANNEL ANALOG MIXER w/ DIGITAL OUT

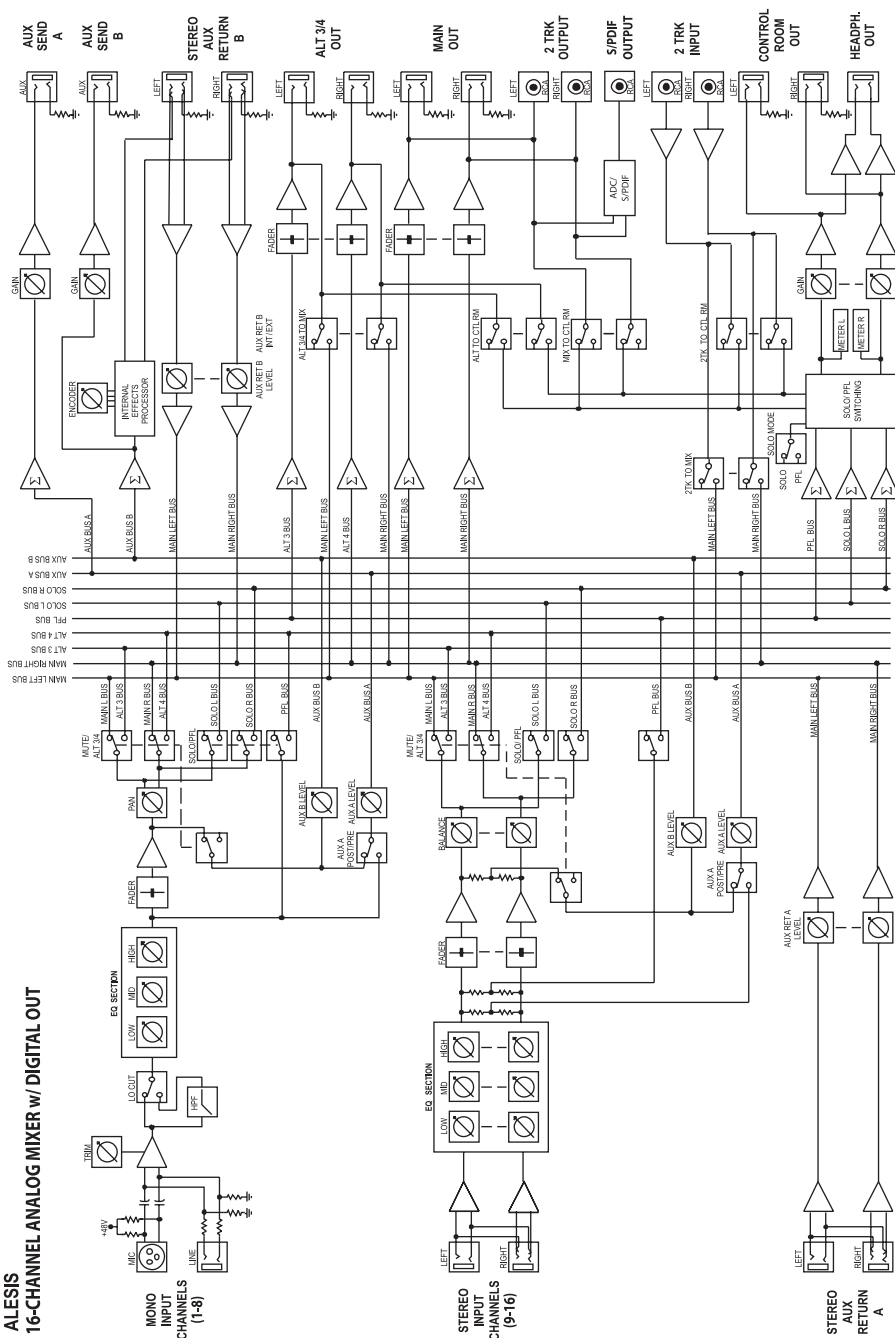

Glossary

Here are the definitions to some terms you'll probably encounter while using your MultiMix FireWire.

Term	Definition
ASIO	Audio Stream Input/Output. An audio protocol developed by Steinberg and used by multiple audio software manufacturers.
aux (auxiliary)	An additional set of outputs and inputs found on many mixers. These allow the addition of external effects and other audio sources.
balance	A control that lets you control the position of sound in a stereo signal by altering the relative levels of the left and right channels.
bus	The electrical component that carries signals from multiple sources to a single destination such as an amplifier.
channel	A path through which an audio signal flows.
channel strip	A section of a mixer on which reside controls like a fader, EQ and pan for manipulating the signal of an input channel.
clipping	The cutting of an audio signal caused by a level that is too great for a mixer circuit to handle.
codec	Compression/decompression algorithm. Different CODECs are used by different digital audio devices and file formats.
condenser microphone	A type of high-quality microphone that produces a weak signal, usually requiring an external power source like the ones provided by your MultiMix's XLR mic inputs.
DAW	Digital audio workstation. DAWs can be either standalone, like the Akai DPS series, or software.
dB (decibel)	A common unit of measure for audio.
detent	A point of resistance in the path that a mixer knob or fader travels. Detents are used to mark important settings. As you turn the knob or slide the fader, you'll feel it "click" into the detent.
dry	Term used to describe an audio signal free of effects. The opposite of "wet."
dynamic microphone	A common type of microphone that does not require external power. Dynamic microphones are generally cheaper than condenser microphones.
effects processor	A unit whose purpose is to provide effects for audio signals. Some common effects include reverb, chorus, flange and delay. Effects processors come in many shapes and sizes, from small pedals up to

Contact Information

	rectangular rackmount units.
EQ (equalizer)	The part of your mixer (or other device) that manipulates an audio signal by lowering the level of some frequencies and increasing the levels of others. EQ is used to fine-tune a signal's highs and lows.
fader	A device that allows you to control the level of an audio signal by sliding the fader up and down a straight path. Each input channel of the MultiMix has its own fader, and so do the MAIN MIX and ALT 3/4.
Firewire	A standard for connecting external devices to a computer. Also called IEEE 1394a.
gain	The measure of extra amplification applied to an audio signal. Channels 1 – 4 on your MultiMix have gain controls, which are useful for boosting mic and line signals.
IEEE 1394a	Another name for Firewire (see above).
latency	The time it takes for audio to travel from the MultiMix, through the computer and the recording program, and out again. Latency is measured in either samples or milliseconds.
level	The amount of power driving an audio signal. The most common names given to levels of varying voltage are, from lowest to highest, microphone level, instrument level and line level.
master section	The section of a mixer where the main mix is controlled.
mic preamp	An amplifier that boosts a microphone-level signal up to line level.
mixer	A device whose purpose is to combine and output a number of audio signals, allowing various types of signal manipulation.
mono (monaural)	Refers to an audio signal that has only one channel. The opposite of stereo.
pan	A control that lets you position a mono signal within the stereo spectrum by altering the level of the signal being sent to the left channel as opposed to the right.
phantom power	A way of providing power to condenser microphones. Called “phantom” because the power isn't apparent to dynamic microphones when you connect them to an input that provides phantom power.
post-fader	Describes an aux send that sends a signal that already has passed through the channel fader.
pre-fader	Describes an aux send that sends a signal that has not passed through the channel fader.

return	A line input whose function is to carry back to the mixer an audio signal that has been sent from the mixer. Usually used in the application of effects.
sample rate	Digital audio is chopped up into tiny time slices. The sample rate is the number of time slices captured in one second. 44.1kHz—44,100 samples per second—is the standard used for Compact Disk audio. 48kHz—48,000 samples per second, is commonly used for film and video.
send	A line output whose function is to send a signal from the mixer to an external device, usually an effects processor.
stereo	Refers to an audio signal that has two channels.
unity gain	Refers to the setting of an audio channel at which the signal leaves the channel at the same level at which it entered. Unity gain is marked by a 0 on the MultiMix's faders.
WDM	The Windows Driver Model. This is the default standard by which Microsoft Windows communicates with audio devices.
wet	An audio signal that has had effects or other manipulations applied. The opposite of “dry.”

Contact Information

Alesis Contact Information

Alesis Distribution, LLC
Los Angeles, CA USA

E-mail: support@alesis.com
Web site: <http://www.alesis.com>

MultiMix FireWire Reference Manual
Revision 1.0 by Edwin Erdmann, Brooks Bruner, and Fred
Morgenstern.

Copyright 2005, Alesis Distribution, LLC. All rights reserved
Reproduction in whole or in part is prohibited. “MultiMix” and
“MultiMix FireWire” are trademarks of Alesis, LLC. Specifications
subject to change without notice.

Trademarks

All trademarks are the property of their respective owners.
Specifically:

“Windows” and “Windows XP” are trademarks of Microsoft
Corporation.

“ASIO” and “Cubase” are trademarks of Steinberg Media
Technologies GmbH.

“Sonar” is a trademark of Twelve Tone Systems, Inc.

“Apple,” “Mac,” “OS X,” and “CoreAudio” are trademarks of
Apple Corporation.

7-51-0197-B
8/02/2005

7-51-0197-B