

# ALESIS®

## ALPHA 112

### **Quickstart Guide**

English ( 3 )

### **Guía de inicio rápido**

Español ( 4 )

### **Guia rápido**

Português ( 5 )

### **Appendix**

English ( 6 )



# Quickstart Guide (English)

## Box Contents

- ALPHA loudspeaker
- Power cable
- Quickstart Guide
- Safety & Warranty Manual

## Connection Diagram / Installation

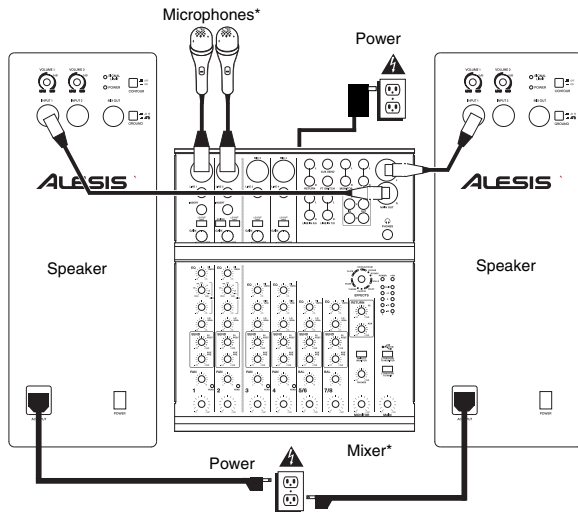

*\*Note: Microphones, mixer, and cables are not included.*

### Installation:

This speaker should be installed on a stand on the floor, according to its maximum weight, or suspended from its suspension weights (M10 x 1.5PH, 30mm length) (see example image). We do NOT recommend suspending multiple speakers in a vertical array.

### Example:

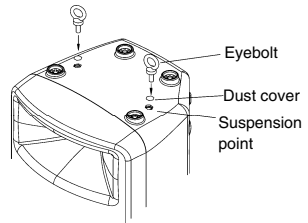

## Rear Panel Overview

- Power Input** – Connect the included power cable to this input and connect the other end of the cable to a power source. Make sure the speaker's power switch is set to "off" when plugging and unplugging the cable.
- Power Switch** – Turns the speaker on/off. Make sure the volume knob is set to "zero" before turning it on.
- Power LED** – Illuminates when the speaker is on.
- Volume** – Turn this knob to adjust the speaker's volume.
- Input** – Use a standard 1/4" TRS or XLR cable (not included) to connect your sound source to this input.
- Mix Out** – Use a standard XLR cable (not included) to connect this jack to the input of another speaker (i.e., another ALPHA loudspeaker).
- Signal Limit LED** – Illuminates when the audio signal being sent to the speaker is "clipping" or distorting. If this light illuminates frequently or steadily, reduce the volume of your sound source.
- Contour** – Engage (depress) this switch to emphasize low and high frequencies by +3 dB. Disengage the switch for flatter response for live performance or for maximum output.
- Ground Switch** – Press this switch to reduce hum or noise.

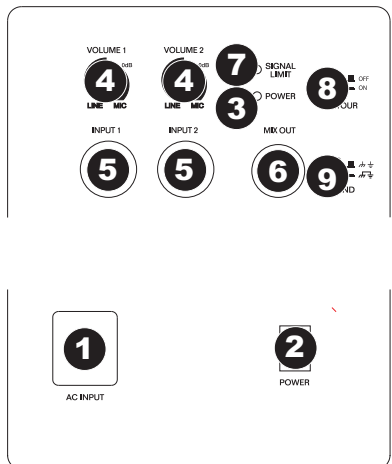

# Guía de inicio rápido (Español)

## Contenido de la caja

- Altavoz ALPHA
- Cable de alimentación
- Guía de inicio rápido
- Folleto de instrucciones de seguridad e información sobre la garantía

## Diagrama de conexión / Instalación

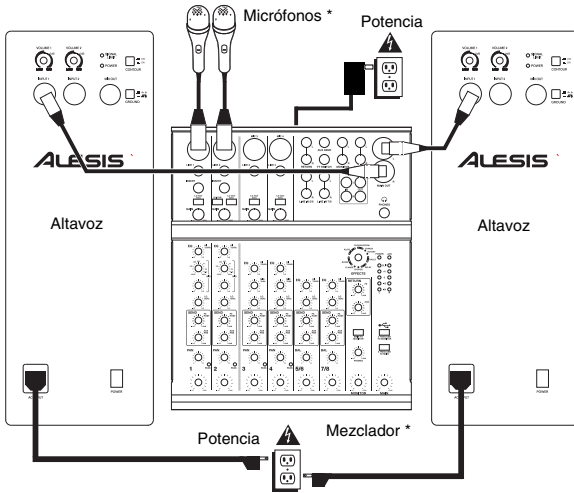

### Instalación:

Este altavoz debe instalarse sobre un soporte colocado en el suelo, de acuerdo a su peso máximo, o suspendido de sus puntos de suspensión (M10 x 1.5PH, 30 mm de longitud) (vea la imagen de ejemplo). NO recomendamos suspender varios altavoces en un arreglo vertical.

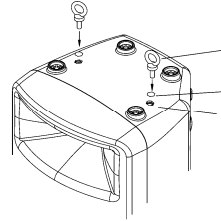

\* Nota: No se incluyen micrófonos, mezclador y cable.

## Vista del panel trasero

1. **Entrada de alimentación** – Conecte a esta entrada el cable de alimentación incluido y luego conecte el otro extremo del cable al suministro eléctrico. Asegúrese de que el interruptor de encendido esté en "off" (apagado) cuando enchufe y desenchufe el cable.
2. **Interruptor de encendido** – Enciende y apaga el altavoz. Asegúrese de que la perilla de volumen esté ajustada a "cero" antes de encenderlo.
3. **LED de encendido** – Se ilumina cuando el altavoz está encendido.
4. **Volumen** – Gire esta perilla para ajustar el volumen del altavoz.
5. **Entrada** – Use un cable de 1/4" TRS o XLR estándar (no incluido) para conectar su fuente de sonido a esta entrada.
6. **Salida de mezcla** – Use un cable XLR estándar (no incluido) para conectar este conector a la entrada de otro altavoz (por ej. otro altavoz ALPHA).
7. **LED de límite de señal** – Se enciende cuando la señal de audio que se envía al altavoz se "recorta" o distorsiona. Si esta luz se enciende con frecuencia o en forma permanente, reduzca el volumen de su fuente de sonido.
8. **Contorno** – Accione (presione) este interruptor para enfatizar las frecuencias bajas y altas en +3 dB. Libere este interruptor para lograr una respuesta más plana en interpretaciones en vivo o para máxima salida.
9. **Interruptor de tierra** – Pulse este interruptor para reducir el zumbido o ruido.

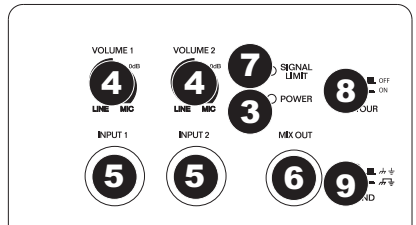

# Guia rápido (Português)

## Conteúdo da embalagem

- Caixa amplificadora ALESIS ALPHA
- Cabo de força
- Guia rápido
- Informações de segurança & livreto de garantia

## Diagrama de conexões e instalação

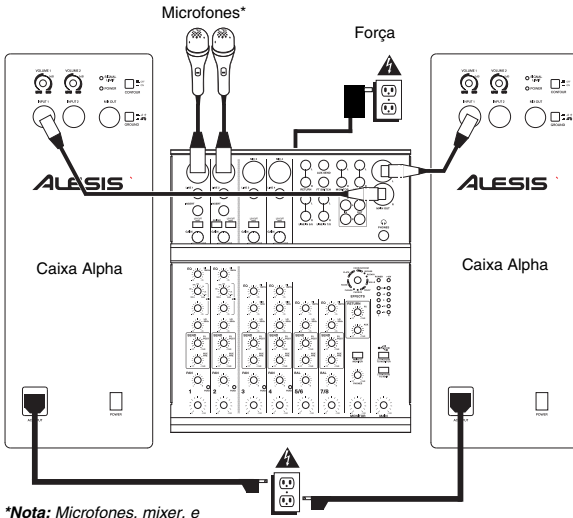

\*Nota: Microfones, mixer, e cabos de sinal não incluídos.

### Instalação:

Esta caixa deve ser instalada em uma estante, no chão, sobreposta de acordo com seu peso máximo, ou suspensa pelos seus pontos de suspensão (M10 x 1.5PH, 30 mm) (vide imagem). Não é recomendada a suspensão de múltiplos gabinetes em coluna.

### Exemplo:

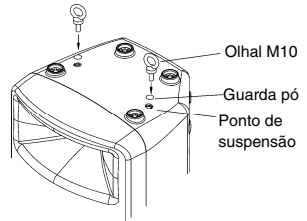

## Visão geral do painel traseiro

- Power input** – Conecte o cabo de força incluso a esta entrada e sua tomada à uma fonte de energia. Certifique-se de que o power switch esteja em "off" ao ligar e desligar o cabo de energia.
- Power switch** – Liga e desliga o aparelho. Certifique-se que o botão de volume esteja em "zero" antes de ligar.
- Power LED** – Acende quando o aparelho estiver ligado.
- Volume** – Ajusta o volume de áudio na entrada correspondente.
- Input** – Use um cabo com conector 1/4" TRS ou XLR (não incluído) para conectar sua fonte de áudio.
- Mix out** – Use um cabo com conector XLR (não incluído) para conectar outra caixa amplificadora (outra caixa ALPHA).
- Signal limit LED** – Acende quando o sinal de áudio enviado ao aparelho está "clipando" ou distorcendo. Se este LED se acende constantemente ou se mantém aceso, diminua o volume de sua fonte de áudio.
- Contour** – Aperte esta chave para aumentar graves e agudos em +3 db. Desaperte para saída "flat", especialmente em performances ao vivo ou para máximo volume.
- Ground switch** – Aperte esta chave para eliminar ruídos ou barulhos de rede elétrica.

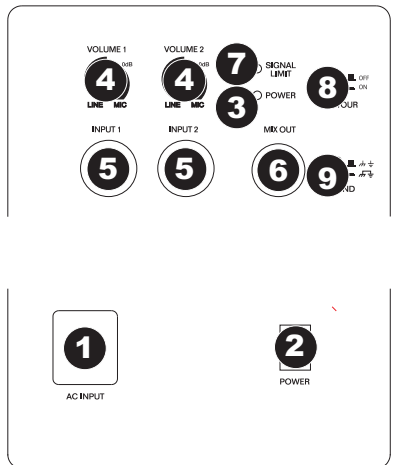

**Appendix (English)**

**Technical Specifications**

<b>Output Power</b>	500 W Continuous RMS (350 W LF + 150 W HF) 1000 W Peak (700 W LF + 300 W HF)
<b>Active Crossover</b>	1.6 kHz, DSP-based, Linkwitz-Riley type
<b>Max SPL @ 1 m</b>	123 dB Continuous; 126 dB Peak
<b>Frequency Range</b>	51 Hz – 20 kHz (@ -10 dB)
<b>Frequency Response</b>	52 Hz – 20 kHz (+3 dB)
<b>Low Frequency</b>	12" (305 mm) neodymium woofer, 2.5" (64 mm) voice coil
<b>High Frequency</b>	Titanium diaphragm compression driver, 1" (25 mm) exit, 1.75" (44 mm) voice coil
<b>Nominal Horn Coverage</b>	80/100° H x 60° V nominal (-6 dB)
<b>Max Input Level</b>	+23 dBu
<b>Input Impedance</b>	15 kΩ
<b>Connectors</b>	Mic/Line Input: two 1/4" TRS or XLR Link Output: one XLR
<b>Cabinet</b>	Trapezoidal with floor monitor capability; injection-molded polypropylene enclosure with perforated steel grille
<b>Mounting</b>	Integrated pole socket (36 mm diameter), 2 handles, 5 M10-threaded sockets (2 bottom, 2 top, 1 pullback)
<b>Protections</b>	Over-excursion, thermal, driver, DSP-based
<b>External Control</b>	Volume, power switch with LED indicator, clip/limit LED, ground lift
<b>Power Supply</b>	100 VAC, 110-120 VAC, 220-240 VAC; 50/60 Hz Inrush current at initial switch-on: 2.24 A Inrush current after power supply interruption: 4.05 A
<b>Dimensions</b> (height x width x depth)	25.5" x 15.1" x 14.4" 648 mm x 384 mm x 365 mm
<b>Weight</b> (loudspeaker only)	31 lbs 14.1 kg

*Specifications are subject to change without notice.*



This device complies with part 15 of the FCC rules. Operation is subject to the following two conditions: (1) this device may not cause harmful interference, and (2) this device must accept any interference received, including interference that may cause undesired operation

**Trademarks and Licenses**

Alesis is a trademark of inMusic Brands, Inc., registered in the U.S. and other countries. All other product or company names are trademarks or registered trademarks of their respective owners.



**alesis.com**